

MANI®



OPHTHALMIC
SUTURES

THE BEST QUALITY IN THE WORLD, TO THE WORLD.

MANI® Ophthalmic Sutures

SUTURE MATERIALS

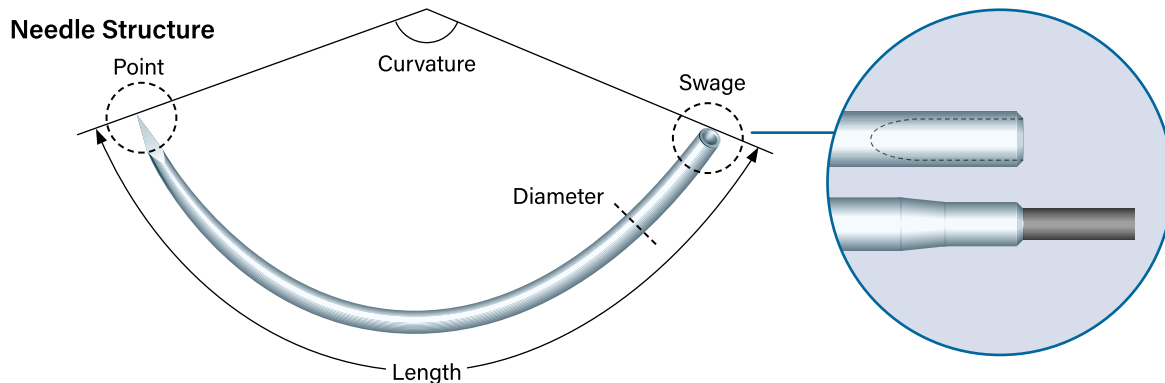

NYLON *Common in Ophthalmic Surgery

Package Sticker Color ●



Absorption	No
Hydrolysis*	No
Handling	Excellent
Possibility of Tissue Reaction	Less
Suture Color	Black, Clear
Monofilament	Yes
Braided	No
Twisted	No
Loops	No
Size	11-0, 10-0, 9-0, 8-0, 7-0, 6-0, 5-0

SILK

Package Sticker Color ●



Absorption	No
Hydrolysis*	No
Handling	Excellent
Possibility of Tissue Reaction	Less
Suture Color	Black, White
Monofilament	No
Braided	Yes
Twisted	No
Loops	No
Size	8-0, 7-0, 6-0, 5-0, 4-0

VIRGIN SILK

Package Sticker Color ●



Absorption	No
Hydrolysis*	No
Handling	Excellent
Possibility of Tissue Reaction	Some
Suture Color	Blue
Monofilament	No
Braided	No
Twisted	Yes
Loops	No
Size	9-0, 8-0

POLYESTER

Package Sticker Color ●



Absorption	No
Hydrolysis*	No
Handling	Good
Possibility of Tissue Reaction	Less
Suture Color	Green, White
Monofilament	No
Braided	Yes
Twisted	No
Loops	No
Size	5-0, 4-0

POLYPROPYLENE

Package Sticker Color ○



Absorption	No
Hydrolysis*	No
Handling	Good
Possibility of Tissue Reaction	Less
Suture Color	Blue
Monofilament	Yes
Braided	No
Twisted	No
Loops	Yes
Size	10-0, 9-0, 7-0, 6-0

PGA

Package Sticker Color ●



Absorption	Yes
Hydrolysis*	Yes
Handling	Excellent
Possibility of Tissue Reaction	Some
Suture Color	Violet
Monofilament	No
Braided	Yes
Twisted	No
Loops	No
Size	8-0, 7-0, 6-0, 5-0

* Please read instruction before use. It is generally said as above, however there are possibility that all materials can be hydrolyzed.

Equivalency

	Material	MANI	Ethicon	Alcon	Sharp
Non Absorbable	Nylon	Nylon	Ethilon (mono) / Nurolon (braided)	Nylon	Nylon
	Silk	Silk	Perma-Hand Silk	Silk	Silk
	Polyester	Polyester	Mersilene (Uncoated) / Ethibond (Coated)	Polyester	Polyviolene
	Polypropylene	Polypropylene	Prolene	Polypropylene	polypropylene
Absorbable	Synthetic Absorbable (Braided)	PGA (polyglycolic acid)	Vicryl	BioSorb	PolySyn / PGA

NEEDLE CHART

Legends of MANI needle code

e.g. **ZG055-14**
 Needle code **ZG** Needle curvature **055** Length (mm) **=5.5mm** Diameter (mm) **=0.14mm**

e.g. **ZG16-14**
 Needle code **ZG** Needle curvature **16** Length (mm) **=16mm** Diameter (mm) **=0.14mm**

Z Trape spatula

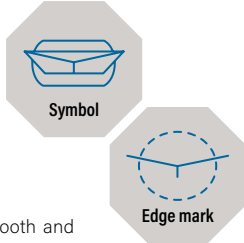

Specially designed spatula edge enabling smooth and stable penetration. Enough strenght and sharpness for sclera and muscles. Generally used for anterior segment surgeries. *Common in Ophthalmic Surgery.

R Reverse cut

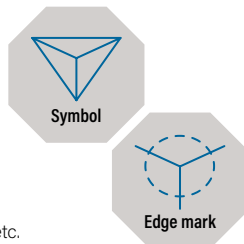

For the hard eye tissue such as Skin, Muscles, etc.

X Dia spatula

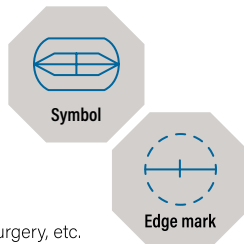

For Retinal detachment, Strabismus, Vitreous surgery, etc.

P Lancet

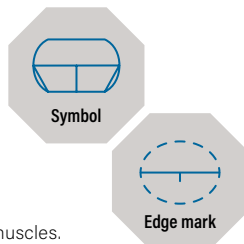

For Oculoplastic such as skin & skin oclar muscles. Smaller trauma than Reverse cutting.

T Taper point

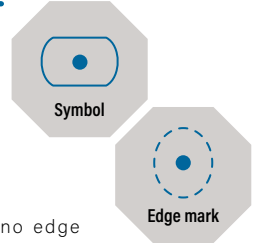

Needle edge is sharply pointed with no edge (Nontraumatic). Used for soft tissues such as conjunctiva.

OV Taper Point (Rectangular)

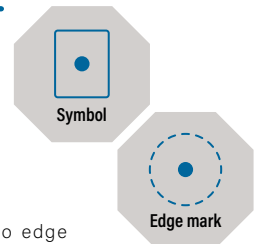

Needle edge is sharply pointed with no edge (Nontraumatic). Needle body is rectangular for enough strength to penetrate Sclera together with conjunctiva.

Y Cut taper

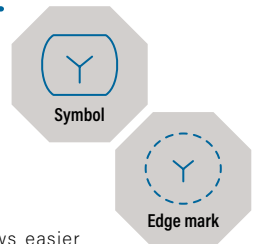

Taper point with side cutting edge allows easier penetration to tissues Used for repositioning of Palpebral furrow, Rectus traction, control suture and etc...

V Spatula side cut

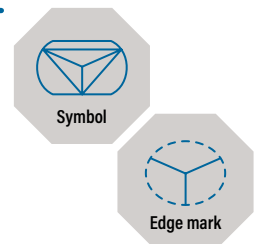

For IOL fixation and Iris repair.

Needle curvature

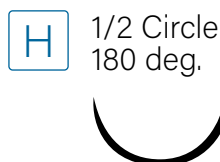
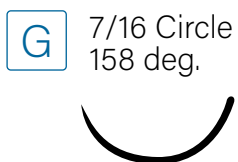
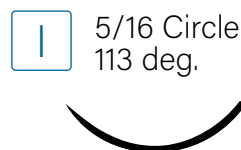
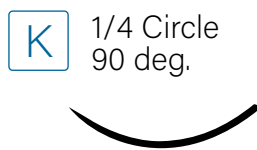
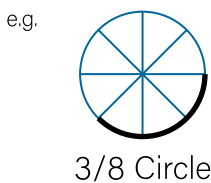

MANI® Suture List by Operation

The following list is for reference only. The sutures are used depending on the surgeon's techniques and preference.

Cataract Surgery

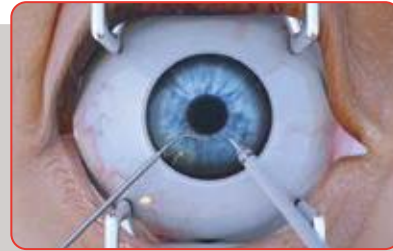

Anterior

Suture			Needle						Main Application	Order No.	
UPS	Description	Length	Image & symbol		Length	Curve	Diam.	Code			
10-0	● Nylon Black Mono	30cm	Trape spatula			6.0mm	3/8 135°	0.14mm	ZE06-14	Sclerocornea	1406
10-0	● Nylon Black Mono	30cm	Trape spatula			6.5mm	3/8 135°	0.20mm	ZE065-20	Sclerocornea	2002
9-0	● Virgin Silk Blue Twisted	45cm	Trape spatula			6.0mm	3/8 135°	0.14mm	ZE06-14	Conjunctiva	1413
8-0	● Virgin Silk Blue Twisted	45cm	Trape spatula			6.5mm	3/8 135°	0.20mm	ZE065-20	Conjunctiva	2024
4-0	● Silk Black Braided	45cm	Taper point			13.0mm	3/8 135°	0.38mm	TE13-38	Control Suture	3801

IOL Fixation















Anterior

Suture			Needle						Main Application	Order No.	
UPS	Description	Length	Image & symbol		Length	Curve	Diam.	Code			
10-0	○ Polypropylene Blue Mono	30cm	Spatula side cut & Trape spatula			16.0mm 4.5mm	Straight 7/16 158°	0.14mm	VS16-14 ZG045-14	IOL Secondary implantation	1455P
10-0	○ Polypropylene Blue Mono	20cm	Spatula side cut			15.0mm	1/4 90°	0.24mm	VK15-24	IOL Secondary implantation	2451L
9-0	○ Polypropylene Blue Mono	30cm	Spatula side cut & Trape spatula			16.0mm 4.5mm	Straight 7/16 158°	0.14mm	VS16-14 ZG045-14	IOL Secondary implantation	1465P
9-0	○ Polypropylene Blue Mono	20cm	Spatula side cut			15.0mm	1/4 90°	0.24mm	VK15-24	IOL Secondary implantation	2452L

Scleral Fixation IOL-Cat. Surgery

Anterior







Suture			Needle						Main Application	Order No.	
UPS	Description	Length	Image & symbol		Length	Curve	Diam.	Code			
8-0	 Nylon Black Mono	30cm	Trape spatula			5.5mm	7/16 158°	0.14mm	ZG055-14	Sclera	1421
8-0	 Nylon Black Mono	30cm	Trape spatula			6.5mm	3/8 135°	0.20mm	ZE065-20	Sclera	2056
8-0	 PGA ABSORBABLE Violet Braided	30cm	Trape spatula			6.0mm	3/8 135°	0.14mm	ZE06-14	Conjunctiva	1490
8-0	 PGA ABSORBABLE Violet Braided	30cm	Trape spatula			6.5mm	3/8 135°	0.20mm	ZE065-20	Conjunctiva	2090

Corneal transplant (KP)



Anterior







04

Suture			Needle						Main Application	Order No.	
UPS	Description	Length	Image & symbol		Length	Curve	Diam.	Code			
10-0	 Nylon Black Mono	30cm	Trape spatula			5.5mm	7/16 158°	0.14mm	ZG055-14	Cornea	1404
10-0	 Nylon Black Mono	30cm	Trape spatula			6.0mm	3/8 135°	0.14mm	ZE06-14	Cornea	1406

Pterygium & Conjunctivochalasis (CCh)















Anterior

Suture			Needle						Main Application	Order No.	
UPS	Description	Length	Image & symbol		Length	Curve	Diam.	Code			
8-0	 Virgin Silk Blue Twisted	45cm	Trape spatula			6.5mm	3/8 135°	0.20mm	ZE065-20	Conjunctiva	2024
8-0	 Nylon Black Mono	30cm	Trape spatula			6.5mm	3/8 135°	0.20mm	ZE065-20	Suturing back of eyelid	2056

The following list is for reference only. The sutures are used depending on the surgeon's techniques and preference.

Sty (Hordeolum) & Chalazion





Anterior

Suture			Needle						Main Application	Order No.	
UPS	Description	Length	Image & symbol		Length	Curve	Diam.	Code			
7-0	 Nylon Black Mono	30cm	Lancet			8.0mm	3/8 135°	0.33mm	PE08-33	Suturing back of eyelid	3361
8-0	 Nylon Black Mono	30cm	Trape spatula			6.5mm	3/8 135°	0.20mm	ZE065-20	Suturing back of eyelid	2056
8-0	 Virgin Silk Blue Twisted	45cm	Trape spatula			6.5mm	3/8 135°	0.20mm	ZE065-20	Suturing back of eyelid	2024
8-0	 PGA ABSORBABLE Violet Braided	30cm	Trape spatula			6.5mm	3/8 135°	0.20mm	ZE065-20	Conjunctiva	2090

Iris Reconstruction

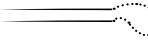















Anterior

Suture			Needle						Main Application	Order No.	
UPS	Description	Length	Image & symbol		Length	Curve	Diam.	Code			
10-0	 Polypropylene Blue Mono	20cm	Spatula side cut			16.0mm	Straight	0.14mm	VS16-14	Iris Reconstruction / IOL Fixation	1470
10-0	 Polypropylene Blue Mono	20cm	Spatula side cut			13.0mm	1/4 90°	0.24mm	VK13-24	Iris Reconstruction / IOL Fixation	2450

Vitreous surgery









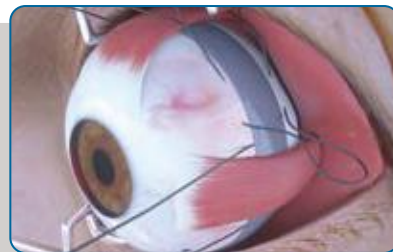

Posterior

Suture			Needle						Main Application	Order No.
UPS	Description	Length	Image & symbol	Length	Curve	Diam.	Code			
5-0	● Polyester White Braided	45cm	Dia spatula 		8.0mm	1/4 90°	0.33mm	XK08-33	Holding Infusion Cannula / Flame of Surgical Lens	3370
8-0	● Nylon Black Mono	30cm	Trape spatula 		5.5mm	7/16 158°	0.14mm	ZG055-14	Closing MVR port	1421
7-0	● Nylon Black Mono	30cm	Trape spatula 		6.5mm	3/8 135°	0.20mm	ZE065-20	Closing MVR port	2058
8-0	● PGA ABSORBABLE Violet Braided	30cm	Trape spatula 		6.5mm	3/8 135°	0.20mm	ZE065-20	Closing MVR port Conjunctiva	2090
7-0	● Silk Black Braided	45cm	Trape spatula 		6.5mm	3/8 135°	0.20mm	ZE065-20	Holding Flame of Surgical Lens	2008
8-0	● Virgin Silk Blue Twisted	45cm	Trape spatula 		6.5mm	3/8 135°	0.20mm	ZE065-20	Conjunctiva	2024
8-0	● PGA ABSORBABLE Violet Braided	30cm	Trape spatula 		6.0mm	3/8 135°	0.14mm	ZE06-14	Conjunctiva	1490

Retinal detachment (Sclera Buckling)



Posterior

Suture			Needle						Main Application	Order No.
UPS	Description	Length	Image & symbol	Length	Curve	Diam.	Code			
4-0	● Silk Black Braided	45cm	Taper point 		13.0mm	3/8 135°	0.38mm	TE13-38	Control Suture	3801
5-0	● Polyester White Braided	45cm	Dia spatula 		8.0mm	1/4 90°	0.33mm	XK08-33	Buckling	3370
7-0	● Silk Black Braided	45cm	Trape spatula 		6.5mm	3/8 135°	0.20mm	ZE065-20	Muscle	2008
8-0	● PGA ABSORBABLE Violet Braided	30cm	Trape spatula 		6.5mm	3/8 135°	0.20mm	ZE065-20	Conjunctiva / Sclera	2090

Glaucoma Surgery

(Sclera Flap & Conjunctiva)



Posterior

Suture			Needle							Main Application	Order No.
UPS	Description	Length	Image & symbol		Length	Curve	Diam.	Code			
10-0	Nylon Black Mono	30cm	Trape spatula			5.5mm	7/16 158°	0.14mm	ZG055-14	Sclera Flap	1404
10-0	Nylon Black Mono	30cm	Trape spatula			6.0mm	3/8 135°	0.14mm	ZE06-14	Sclera Flap	1406
10-0	Nylon Black Mono	30cm	Taper point			5.5mm	7/16 158°	0.14mm	TG055-14	Conjunctiva	1475
10-0	Nylon Black Mono	45cm	Taper point			6.0mm	3/8 135°	0.14mm	TE06-14	Conjunctiva	1459
10-0	Nylon Black Mono	30cm	Taper point ractenguler			6.5mm	3/8 135°	0.14mm	OVE065-14	Conjunctiva	1430
6-0	Silk Black Braided	45cm	Trape spatula			6.5mm	3/8 135°	0.28mm	ZE065-28	Control	2801

07

Strabismus



Posterior

Suture			Needle							Main Application	Order No.
UPS	Description	Length	Image & symbol		Length	Curve	Diam.	Code			
6-0	PGA ABSORBABLE Violet Braided	45cm	Dia spatula			8.5mm	1/4 90°	0.28mm	XK085-28	Conjunctiva / Sclera	2890
5-0	PGA ABSORBABLE Violet Braided	45cm	Dia spatula			8.5mm	1/4 90°	0.33mm	XK085-33	Conjunctiva / Sclera	3391
8-0	Nylon Black Mono	30cm	Trape spatula			6.5mm	3/8 135°	0.20mm	ZE065-20	Conjunctiva / Sclera	2056
4-0	Silk Black Braided	50cm	Single-armed / Lancet			13.0mm	3/8 135°	0.43mm	PEI3-43	Control Suture	4359S
4-0	Silk Black Braided	45cm	Taper point			13.0mm	3/8 135°	0.38mm	TEI3-38	Control Suture	3801
8-0	PGA ABSORBABLE Violet Braided	30cm	Trape spatula			6.5mm	3/8 135°	0.20mm	ZE065-20	Conjunctiva	2090

The following list is for reference only. The sutures are used depending on the surgeon's techniques and preference.

Double Eyelid Surgery & Trichiasis (Ingrowing eyelashes)



Oculoplasty

Suture			Needle							Main Application	Order No.
UPS	Description	Length	Image & symbol		Length	Curve	Diam.	Code			
7-0	● Nylon Black Mono	30cm	Cut taper			15.0mm	3/8 135°	0.33mm	YE15-33	Reposition of palpebral furrow	3365
7-0	● Nylon Clear Mono	30cm	Cut taper			15.0mm	3/8 135°	0.33mm	YE15-33	Reposition of palpebral furrow	3388
6-0	● Nylon Black Mono	30cm	Cut taper			15.0mm	3/8 135°	0.33mm	YE15-33	Reposition of palpebral furrow	3386
7-0	○ Polypropylene Blue Mono	30cm	Cut taper			15.0mm	3/8 135°	0.33mm	YE15-33	Reposition of palpebral furrow	3309
6-0	○ Polypropylene Blue Mono	30cm	Cut taper			15.0mm	3/8 135°	0.33mm	YE15-33	Reposition of palpebral furrow	3312

08

Ptosis (Drooping eyelid)















Oculoplasty































Suture			Needle							Main Application	Order No.
UPS	Description	Length	Image & symbol		Length	Curve	Diam.	Code			
7-0	● Nylon Black Mono	30cm	Lancet			8.0mm	3/8 135°	0.33mm	PE08-33	Skin	3361
7-0	● Nylon Black Mono	50cm	Lancet			11.0mm	3/8 135°	0.33mm	PE11-33	Skin	3364
6-0	● Nylon Black Mono	50cm	Lancet			11.0mm	3/8 135°	0.33mm	PE11-33	Skin	3382
7-0	○ Polypropylene Blue Mono	60cm	Cut taper			11.0mm	3/8 135°	0.33mm	Y5E11-33	Skin	3314
6-0	○ Polypropylene Blue Mono	60cm	Cut taper			11.0mm	3/8 135°	0.33mm	Y5E11-33	Skin	3317

MANI® Ophthalmic Sutures

11-0 (0.1metric) Needled Sutures





























Suture		Needle						Main Application	Order No.	
Description	Length	Image & symbol		Length	Curve	Diam.	Code			
● Nylon Black Mono	13cm	Taper point Single-armed			4.0mm	3/8 135°	0.05mm	OE04-05	For laboratories	0550S
	20cm	Trape spatula			5.5mm	7/16 158°	0.10mm	ZG055-10	Sclerocornea	1000
	10cm	Trape spatula Single-armed			5.5mm	7/16 158°	0.10mm	ZG055-10		1000S
	20cm	Trape spatula			5.5mm	7/16 158°	0.14mm	ZG055-14		1403
	30cm	Trape spatula			5.5mm	7/16 158°	0.14mm	ZG055-14		1476
	10cm	Trape spatula Single-armed			6.0mm	3/8 135°	0.14mm	ZE06-14		1478S

10-0 (0.2metric) Needled Sutures













Suture		Needle						Main Application	Order No.	
Description	Length	Image & symbol		Length	Curve	Diam.	Code			
● Nylon Black Mono	30cm	Trape spatula			5.0mm	Bi-curve 90°/50°	0.14mm	ZB05-14	Sclerocornea	1401
	15cm	Trape spatula Single-armed			5.0mm	Bi-curve 90°/50°	0.14mm	ZB05-14		1401S
	20cm	Trape spatula			5.0mm	Bi-curve 90°/50°	0.14mm	ZB05-14		1474
	30cm	Trape spatula			5.5mm	7/16 158°	0.10mm	ZG055-10		1001
	30cm	Trape spatula			5.5mm	7/16 158°	0.14mm	ZG055-14		1404
	15cm	Trape spatula Single-armed			5.5mm	7/16 158°	0.14mm	ZG055-14		1404S
	15cm	Trape spatula			5.5mm	7/16 158°	0.14mm	ZG055-14		1482
	30cm	Trape spatula			5.5mm	7/16 158°	0.20mm	ZG055-20		2000
	30cm	Trape spatula			6.0mm	3/8 135°	0.14mm	ZE06-14		1406
	15cm	Trape spatula Single-armed			6.0mm	3/8 135°	0.14mm	ZE06-14		1406S
	6cm	Trape spatula Single-armed			6.0mm	3/8 135°	0.14mm	ZE06-14		1468S
	15cm	Trape spatula			6.0mm	3/8 135°	0.14mm	ZE06-14		1452
	30cm	Trape spatula			6.5mm	3/8 135°	0.20mm	ZE065-20		2002
	15cm	Trape spatula Single-armed			6.5mm	3/8 135°	0.20mm	ZE065-20		2002S
	30cm	Trape spatula			7.0mm	1/2 180°	0.14mm	ZH07-14		1410

Suture	USA	EU
● Silk / Virgin Silk	Available	Available
● Nylon	Available	Available
● Polyester	Available	Available
○ Polypropylene	Not Available	Available
● PGA	Available	Not Available

10-0 (0.2metric) Needled Sutures





















Suture		Needle						Main Application	Order No.	
Description	Length	Image & symbol		Length	Curve	Diam.	Code			
● Nylon Black Mono	15cm	Trape spatula Single-armed			7.0mm	1/2 180°	0.14mm	ZH07-14	Sclerocornea	1410S
	20cm	Taper point Single-armed			4.0mm	3/8 135°	0.10mm	TE04-10	Conjunctiva for Glaucoma	1053S
	20cm	Taper point Single-armed			5.0mm	3/8 135°	0.10mm	TE05-10		1052S
	30cm	Taper point			5.5mm	7/16 158°	0.14mm	TG055-14		1475
	45cm	Taper point			6.0mm	3/8 135°	0.14mm	TE06-14		1459
	13cm	Taper point Single-armed			6.0mm	3/8 135°	0.14mm	TE06-14		1459S
	30cm	Taper point rectangular			6.5mm	3/8 135°	0.14mm	OVE065-14		1430
	15cm	Taper point rectangular Single-armed			6.5mm	3/8 135°	0.14mm	OVE065-14		1430S
	30cm	Taper point rectangular			6.0mm	7/16 158°	0.14mm	OVG06-14		1432
	30cm	Taper point rectangular			6.0mm	3/8 135°	0.14mm	OVE06-14		1433
○ Polypropylene Blue Mono	30cm	Trape spatula			5.5mm	7/16 158°	0.14mm	ZG055-14		Sclerocornea
	30cm	Trape spatula			6.0mm	3/8 135°	0.14mm	ZE06-14	1417	
	15cm	Trape spatula Single-armed			6.0mm	3/8 135°	0.14mm	ZE06-14	1417S	
	30cm	Trape spatula			6.5mm	3/8 135°	0.20mm	ZE065-20	2021	

9-0 (0.3metric) Needled Sutures

























Suture		Needle						Main Application	Order No.	
Description	Length	Image & symbol		Length	Curve	Diam.	Code			
● Nylon Black Mono	30cm	Trape spatula			5.0mm	Bi-curve 90°/50°	0.14mm	ZB05-14	Sclerocornea	1402
	30cm	Trape spatula			5.5mm	7/16 158°	0.14mm	ZG055-14		1405
	30cm	Trape spatula			6.0mm	3/8 135°	0.14mm	ZE06-14		1407
	15cm	Trape spatula Single-armed			6.0mm	3/8 135°	0.14mm	ZE06-14		1407S
	30cm	Trape spatula			6.5mm	3/8 135°	0.20mm	ZE065-20		2003
	15cm	Trape spatula Single-armed			6.5mm	3/8 135°	0.20mm	ZE065-20		2003S

Suture	USA	EU
● Silk / Virgin Silk	Available	Available
● Nylon	Available	Available
● Polyester	Available	Available
○ Polypropylene	Not Available	Available
● PGA	Available	Not Available















9-0 (0.3metric) Needled Sutures

Suture		Needle						Main Application	Order No.	
Description	Length	Image & symbol		Length	Curve	Diam.	Code			
● Virgin Silk Blue Twisted	45cm	Trape spatula			5.5mm	7/16 158°	0.14mm	ZG055-14	Sclerocornea	1453
	45cm	Trape spatula			6.0mm	3/8 135°	0.14mm	ZE06-14		1413
	20cm	Trape spatula Single-armed			6.0mm	3/8 135°	0.14mm	ZE06-14		1413S
	15cm	Trape spatula			6.0mm	3/8 135°	0.14mm	ZE06-14		1480
	45cm	Trape spatula			6.5mm	3/8 135°	0.20mm	ZE065-20		2020
	20cm	Trape spatula Single-armed			6.5mm	3/8 135°	0.20mm	ZE065-20		2020S
	45cm	Taper point			6.0mm	3/8 135°	0.14mm	TE06-14		Conjunctiva for Glaucoma
○ Polypropylene Blue Mono	30cm	Trape spatula			5.5mm	7/16 158°	0.14mm	ZG055-14	Sclerocornea	1416
	30cm	Trape spatula			6.0mm	3/8 135°	0.14mm	ZE06-14		1418
	30cm	Trape spatula			6.5mm	3/8 135°	0.20mm	ZE065-20		2022































8-0 (0.4metric) Needled Sutures

Suture		Needle						Main Application	Order No.	
Description	Length	Image & symbol		Length	Curve	Diam.	Code			
● Nylon Black Mono	30cm	Trape spatula			5.5mm	7/16 158°	0.14mm	ZG055-14	Sclera	1421
	30cm	Trape spatula			6.5mm	1/4 90°	0.20mm	ZK065-20		2054
	30cm	Trape spatula			6.5mm	3/8 135°	0.20mm	ZE065-20		2056
	30cm	Trape spatula			7.0mm	1/2 180°	0.20mm	ZH07-20		2028
	50cm	Reverse cut			11.0mm	3/8 135°	0.24mm	RE11-24	Skin	2461
50cm	Reverse cut			11.0mm	3/8 135°	0.24mm	RE11-24	2461S		
● Silk Black Braided	45cm	Trape spatula			6.0mm	3/8 135°	0.18mm	ZE06-18	Sclera and Conjunctiva	1467
	45cm	Trape spatula			6.5mm	3/8 135°	0.20mm	ZE065-20		2023
	20cm	Trape spatula Single-armed			6.5mm	3/8 135°	0.20mm	ZE065-20		2023S
● Virgin Silk Blue Twisted	45cm	Trape spatula			6.0mm	3/8 135°	0.14mm	ZE06-14	Sclera and Conjunctiva	1419
	45cm	Trape spatula			6.5mm	3/8 135°	0.20mm	ZE065-20		2024
	20cm	Trape spatula Single-armed			6.5mm	3/8 135°	0.20mm	ZE065-20		2024S

8-0 (0.4metric) Needled Sutures

Suture		Needle						Main Application	Order No.	
Description	Length	Image & symbol		Length	Curve	Diam.	Code			
● Virgin Silk Blue Twisted	30cm	Trape spatula			6.5mm	3/8 135°	0.20mm	ZE065-20	Sclera and Conjunctiva	2051
	45cm	Trape spatula			7.0mm	1/2 180°	0.20mm	ZH07-20		2019
	45cm	Taper point			6.0mm	3/8 135°	0.14mm	TE06-14	Conjunctiva for Glaucoma	1466
● PGA ABSORBABLE Violet Braided	30cm	Trape spatula			6.0mm	3/8 135°	0.14mm	ZE06-14	Sclera and Conjunctiva	1490
	30cm	Trape spatula			6.5mm	3/8 135°	0.20mm	ZE065-20		2090
	20cm	Trape spatula Single-armed			6.5mm	3/8 135°	0.20mm	ZE065-20		2090S
	30cm	Taper point			6.0mm	3/8 135°	0.14mm	TE06-14	Conjunctiva for Glaucoma	1491



























7-0 (0.5metric) Needled Sutures

Suture		Needle						Main Application	Order No.	
Description	Length	Image & symbol		Length	Curve	Diam.	Code			
● Nylon Black Mono	30cm	Trape spatula			5.5mm	7/16 158°	0.14mm	ZG055-14	Sclera	1457
	30cm	Trape spatula			6.5mm	3/8 135°	0.20mm	ZE065-20		2058
	45cm	Trape spatula			8.0mm	3/8 135°	0.28mm	ZE08-28		2855
	45cm	Reverse cut Single-armed			7.0mm	3/8 135°	0.24mm	RE07-24	Skin	2455S
	50cm	Reverse cut Single-armed			9.0mm	3/8 135°	0.24mm	RE09-24		2457S
	30cm	Reverse cut			11.0mm	3/8 135°	0.24mm	RE11-24		2463
	30cm	Lancet			8.0mm	3/8 135°	0.33mm	PE08-33		3361
	45cm	Lancet Single-armed			8.0mm	3/8 135°	0.33mm	PE08-33		3361S
	50cm	Lancet			11.0mm	3/8 135°	0.33mm	PE11-33		3364
	50cm	Lancet Single-armed			11.0mm	3/8 135°	0.33mm	PE11-33		3364S
● Nylon Clear Mono	30cm	Cut taper			15.0mm	3/8 135°	0.33mm	YE15-33	Repositioning of Palpebral furrow	3365
	30cm	Cut taper			15.0mm	3/8 135°	0.33mm	YE15-33		3388
● Silk Black Braided	45cm	Trape spatula			6.5mm	3/8 135°	0.20mm	ZE065-20	Sclera and Conjunctiva	2008
	30cm	Trape spatula			6.5mm	3/8 135°	0.20mm	ZE065-20		2063
	30cm	Trape spatula Single-armed			6.5mm	3/8 135°	0.20mm	ZE065-20		2008S



















12

Suture	USA	EU
● Silk / Virgin Silk	Available	Available
● Nylon	Available	Available
● Polyester	Available	Available
○ Polypropylene	Not Available	Available
● PGA	Available	Not Available















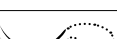
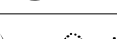
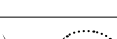
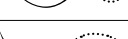
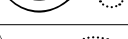

7-0 (0.5metric) Needled Sutures

Suture		Needle						Main Application	Order No.	
Description	Length	Image & symbol		Length	Curve	Diam.	Code			
● Silk Black Braided	45cm	Trape spatula Single-armed			8.0mm	1/2 180°	0.20mm	ZH08-20	Sclera and Conjunctiva	2062S
	50cm	Lancet Single-armed			7.0mm	3/8 135°	0.28mm	PE07-28	Skin	2860S
● Silk White Braided	45cm	Trape spatula Single-armed			8.0mm	1/2 180°	0.20mm	ZH08-20	Sclera and Conjunctiva	2068S
○ Polypropylene Blue Mono	45cm	Lancet Single-armed			8.0mm	3/8 135°	0.33mm	PE08-33	Skin-Ocular muscles	3306S
	45cm	Lancet Single-armed			11.0mm	3/8 135°	0.33mm	PE11-33		3307S
	30cm	Cut taper			15.0mm	3/8 135°	0.33mm	YE15-33		3309
	60cm	Cut taper			9.0mm	3/8 135°	0.33mm	Y5E09-33		3313
	50cm	Cut taper Single-armed			9.0mm	3/8 135°	0.33mm	Y5E09-33		3313S
	60cm	Cut taper			11.0mm	3/8 135°	0.33mm	Y5E11-33		3314
	50cm	Cut taper Single-armed			11.0mm	3/8 135°	0.33mm	Y5E11-33		3314S
● PGA ABSORBABLE Violet Braided	30cm	Trape spatula			6.5mm	3/8 135°	0.20mm	ZE065-20	Sclera and Conjunctiva	2091
	30cm	Trape spatula Single-armed			6.5mm	3/8 135°	0.20mm	ZE065-20		2091S
	45cm	Trape spatula			5.5mm	7/16 158°	0.20mm	ZG055-20		2092

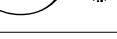
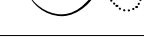
6-0 (0.7metric) Needled Sutures

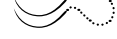
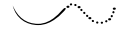



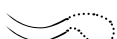













































Suture		Needle						Main Application	Order No.	
Description	Length	Image & symbol		Length	Curve	Diam.	Code			
● Nylon Black Mono	45cm	Trape spatula			8.0mm	3/8 135°	0.28mm	ZE08-28	Sclera-Ocular muscles	2854
	45cm	Trape spatula			8.0mm	7/16 158°	0.28mm	ZG08-28		2859
	30cm	Reverse cut			13.0mm	3/8 135°	0.28mm	RE13-28	Skin-Ocular muscles	2808
	20cm	Reverse cut Single-armed			13.0mm	3/8 135°	0.28mm	RE13-28		2808S
	30cm	Lancet Single-armed			7.0mm	3/8 135°	0.33mm	PE07-33		3379S
	50cm	Lancet Single-armed			8.0mm	1/2 180°	0.33mm	PH08-33	3362S	
	45cm	Lancet Single-armed			11.0mm	1/2 180°	0.33mm	PH11-33	3381S	
	50cm	Lancet			11.0mm	3/8 135°	0.33mm	PE11-33	3382	
	45cm	Lancet Single-armed			11.0mm	3/8 135°	0.33mm	PE11-33	3382S	

6-0 (0.7metric) Needled Sutures







Suture		Needle						Main Application	Order No.
Description	Length	Image & symbol	Length	Curve	Diam.	Code			
● Nylon Black Mono	45cm	Lancet Single-armed		11.0mm	3/8 135°	0.38mm	PE11-38	Skin-Ocular muscles	3853S
	45cm	Lancet Single-armed		13.0mm	1/2 180°	0.33mm	PH13-33		3363S
	30cm	Cut taper		15.0mm	3/8 135°	0.33mm	YE15-33	Repositioning of Palpebral furrow	3386
● Nylon Clear Mono	50cm	Lancet		11.0mm	3/8 135°	0.33mm	PE11-33	Skin-Ocular muscles	3387
● Silk Black Braided	45cm	Trape spatula		5.5mm	7/16 158°	0.28mm	ZG055-28	Sclera-Ocular muscles	2804
	45cm	Trape spatula		6.5mm	3/8 135°	0.28mm	ZE065-28		2801
	50cm	Trape spatula Single-armed		10.0mm	3/8 135°	0.33mm	ZE10-33		3354S
	45cm	Reverse cut		7.0mm	3/8 135°	0.28mm	RE07-28	Skin-Ocular muscles	2853
	45cm	Reverse cut		8.0mm	5/16 113°	0.28mm	RI08-28		2805
	45cm	Reverse cut		11.0mm	3/8 135°	0.33mm	RE11-33		3305
	45cm	Reverse cut Single-armed		11.0mm	3/8 135°	0.33mm	RE11-33	Control suture-Skin-Ocular muscles	3305S
	55cm	Lancet		10.0mm	3/8 135°	0.33mm	PE 10-33		3366
	55cm	Taper point		13.0mm	3/8 135°	0.33mm	TE13-33	Control suture	3356
	55cm	Cut taper		13.0mm	3/8 135°	0.33mm	YE13-33		3353
	60cm	Cut taper Single-armed		14.0mm	3/8 135°	0.38mm	YE14-38		3850S
	○ Polypropylene Blue Mono	45cm	Lancet Single-armed		11.0mm	3/8 135°	0.33mm	PE11-33	Skin-Ocular muscles
30cm		Cut taper		15.0mm	3/8 135°	0.33mm	YE15-33	3312	
60cm		Cut taper		9.0mm	3/8 135°	0.33mm	Y5E09-33	3316	
50cm		Cut taper Single-armed		9.0mm	3/8 135°	0.33mm	Y5E09-33	3316S	
60cm		Cut taper		11.0mm	3/8 135°	0.33mm	Y5E11-33	3317	
50cm		Cut taper Single-armed		11.0mm	3/8 135°	0.33mm	Y5E11-33	3317S	
● PGA ABSORBABLE Violet Braided	45cm	Trape spatula		6.5mm	1/4 90°	0.24mm	ZK065-24	Heterotropia-Ocular muscles	2490
	45cm	Dia spatula		8.5mm	1/4 90°	0.28mm	XK085-28		2890
	30cm	Lancet		11.0mm	3/8 135°	0.33mm	PE11-33	Skin-Ocular muscles	3393

Suture	USA	EU
● Silk / Virgin Silk	Available	Available
● Nylon	Available	Available
● Polyester	Available	Available
○ Polypropylene	Not Available	Available
● PGA	Available	Not Available













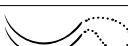

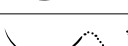

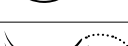



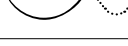







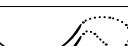

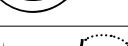





5-0 (1.0metric) Needled Sutures

Suture		Needle						Main Application	Order No.	
Description	Length	Image & symbol	Image & symbol	Length	Curve	Diam.	Code			
● Nylon Black Mono	30cm	Trape spatula			6.0mm	1/4 90°	0.28mm	ZK06-28	Sclera-Ocular muscles	2806
	45cm	Trape spatula			7.0mm	3/8 135°	0.28mm	ZE07-28		2865
	45cm	Trape spatula			8.0mm	3/8 135°	0.28mm	ZE08-28		2856
	45cm	Dia spatula			6.0mm	1/4 90°	0.28mm	XK06-28		2807
	45cm	Lancet Single-armed			11.0mm	1/2 180°	0.33mm	PH11-33	Skin-Ocular muscles	3383S
	50cm	Reverse cut			11.0mm	3/8 135°	0.38mm	RE11-38		3854
	45cm	Reverse cut Single-armed			11.0mm	3/8 135°	0.38mm	RE11-38		3854S
● Silk Black Braided	50cm	Reverse cut Single-armed			11.0mm	3/8 135°	0.43mm	RE11-43	Control suture-Skin-Ocular muscles	4350S
	50cm	Reverse cut Single-armed			13.0mm	3/8 135°	0.33mm	RE13-33		3358S
	50cm	Lancet			11.0mm	3/8 135°	0.38mm	PE11-38		3856
	50cm	Lancet Single-armed			11.0mm	3/8 135°	0.38mm	PE11-38		3856S
	45cm	Taper point			13.0mm	3/8 135°	0.33mm	TE13-33	Control suture	3355
	30cm	Taper point Single-armed			13.0mm	3/8 135°	0.33mm	TE13-33		3355S
	60cm	Taper point			16.0mm	3/8 135°	0.38mm	TE16-38		3855
	30cm	Taper point Single-armed			16.0mm	3/8 135°	0.38mm	TE16-38		3855S
● Polyester White Braided	45cm	Trape spatula			8.0mm	1/4 90°	0.33mm	ZK08-33	Operations on Vitreous	3377
	45cm	Dia spatula			6.0mm	1/4 90°	0.28mm	X1K06-28		2863
	45cm	Dia spatula			6.0mm	1/4 90°	0.33mm	XK06-33		3372
	45cm	Dia spatula			8.0mm	1/4 90°	0.33mm	XK08-33		3370
	45cm	Dia spatula			8.0mm	1/2 180°	0.33mm	XH08-33		3371
	75cm	Taper point			10.0mm	3/8 135°	0.33mm	TE10-33		3380
● Polyester Green Braided	45cm	Trape spatula			8.0mm	1/4 90°	0.33mm	ZK08-33	3376	
	45cm	Dia spatula			6.0mm	1/4 90°	0.33mm	XK06-33	3375	
	45cm	Dia spatula			8.0mm	1/4 90°	0.33mm	XK08-33	3373	
	45cm	Dia spatula			8.0mm	1/2 180°	0.33mm	XH08-33	3374	

5-0 (1.0metric) Needled Sutures

Suture		Needle						Main Application	Order No.	
Description	Length	Image & symbol		Length	Curve	Diam.	Code			
● Polyester Green Braided	75cm	Taper point			10.0mm	3/8 135°	0.33mm	TE10-33	Operations on Vitreous	3378
● PGA ABSORBABLE Violet Braided	45cm	Dia spatula			8.5mm	1/4 90°	0.33mm	XK085-33	Heterotropia-Ocular muscles	3391
	30cm	Dia spatula			8.0mm	1/4 90°	0.33mm	XK08-33		3392











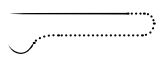

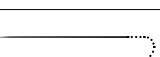

4-0 (1.5metric) Needled Sutures

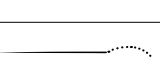
Suture		Needle						Main Application	Order No.	
Description	Length	Image & symbol		Length	Curve	Diam.	Code			
● Silk Black Braided	45cm	Reverse cut			13.0mm	7/16 158°	0.43mm	RG13-43	Control suture	4300
	50cm	Reverse cut			13.0mm	3/8 135°	0.43mm	RE13-43		4351
	50cm	Reverse cut Single-armed			13.0mm	3/8 135°	0.43mm	RE13-43		4351S
	55cm	Lancet			13.0mm	3/8 135°	0.43mm	PE13-43		4359
	50cm	Lancet Single-armed			13.0mm	3/8 135°	0.43mm	PE13-43		4359S
	45cm	Taper point			13.0mm	3/8 135°	0.38mm	TE13-38		3801
	45cm	Taper point Single-armed			13.0mm	3/8 135°	0.38mm	TE13-38		3801S
	55cm	Taper point			13.0mm	3/8 135°	0.38mm	TE13-38		3851
	45cm	Taper point			16.0mm	3/8 135°	0.38mm	TE16-38		3861
	75cm	Taper point			16.0mm	1/2 180°	0.53mm	TH16-53		5351
75cm	Cut taper Single-armed			14.0mm	3/8 135°	0.43mm	YE14-43	4302S		
● Silk White Braided	45cm	Taper point			25.0mm	7/16 158°	0.38mm	TG25-38	Skin	3857
	60cm	Dia spatula			6.5mm	1/4 90°	0.43mm	XK065-43	Operations on Vitreous	4360
● Polyester White Braided	45cm	Trape spatula			8.0mm	1/4 90°	0.43mm	ZK08-43		4356
	45cm	Dia spatula			6.5mm	1/4 90°	0.43mm	XK065-43		4357
	45cm	Dia spatula			8.0mm	1/4 90°	0.43mm	XK08-43		4352
● Polyester Green Braided	45cm	Trape spatula			8.0mm	1/4 90°	0.43mm	ZK08-43		4355
	45cm	Dia spatula			8.0mm	1/4 90°	0.43mm	XK08-43		4353

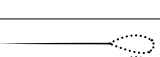

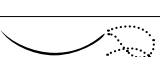

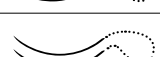

16

Suture	USA	EU
● Silk / Virgin Silk	Available	Available
● Nylon	Available	Available
● Polyester	Available	Available
○ Polypropylene	Not Available	Available
● PGA	Available	Not Available

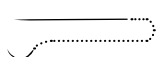
10-0 (0.2metric) Needled Sutures for Secondary Implantation

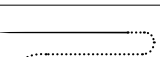
Suture		Needle						Main Application	Order No.		
Description	Length	Image & symbol	Length	Curve	Diam.	Code					
○ Polypropylene Blue Mono	30cm	Spatula side cut Trape Spatula			16.0mm	Straight	0.14mm	VS16-14	Pair double-armed	1458P	
					4.5mm	7/16 158°	0.14mm	ZG045-14			
	30cm	Spatula side cut Trape Spatula			18.0mm	1/4 90°	0.24mm	VK18-24		1458P	
					6.0mm	3/8 135°	0.14mm	ZE06-14			
	30cm	Spatula side cut Trape Spatula			18.0mm	Straight	0.14mm	VS18-14		1460P	
					4.5mm	7/16 158°	0.14mm	ZG045-14			
	20cm	Spatula side cut			16.0mm	Straight	0.14mm	VS16-14		Iris Reconstruction / IOL Fixation	1470
	15cm	Spatula side cut			16.0mm	Straight	0.14mm	VS16-14		Needed suture with loop	1486L
20cm	Spatula side cut			15.0mm	1/4 90°	0.24mm	VK15-24	2451L			
20cm	Spatula side cut			13.0mm	1/4 90°	0.24mm	VK13-24	Iris Reconstruction / IOL Fixation	2450		

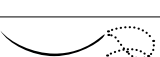
9-0 (0.3metric) Needled Sutures for Secondary Implantation

Suture		Needle						Main Application	Order No.	
Description	Length	Image & symbol	Length	Curve	Diam.	Code				
○ Polypropylene Blue Mono	30cm	Spatula side cut Trape Spatula			16.0mm	Straight	0.14mm	VS16-14	Pair double-armed	1465P
					4.5mm	7/16 158°	0.14mm	ZG045-14		
	30cm	Spatula side cut Trape Spatula			18.0mm	Straight	0.14mm	VS18-14		1494P
					4.5mm	7/16 158°	0.14mm	ZG045-14		
20cm	Spatula side cut			15.0mm	1/4 90°	0.24mm	VK15-24	Needed suture with loop	2452L	

HUMAN EYE IN CROSS SECTION

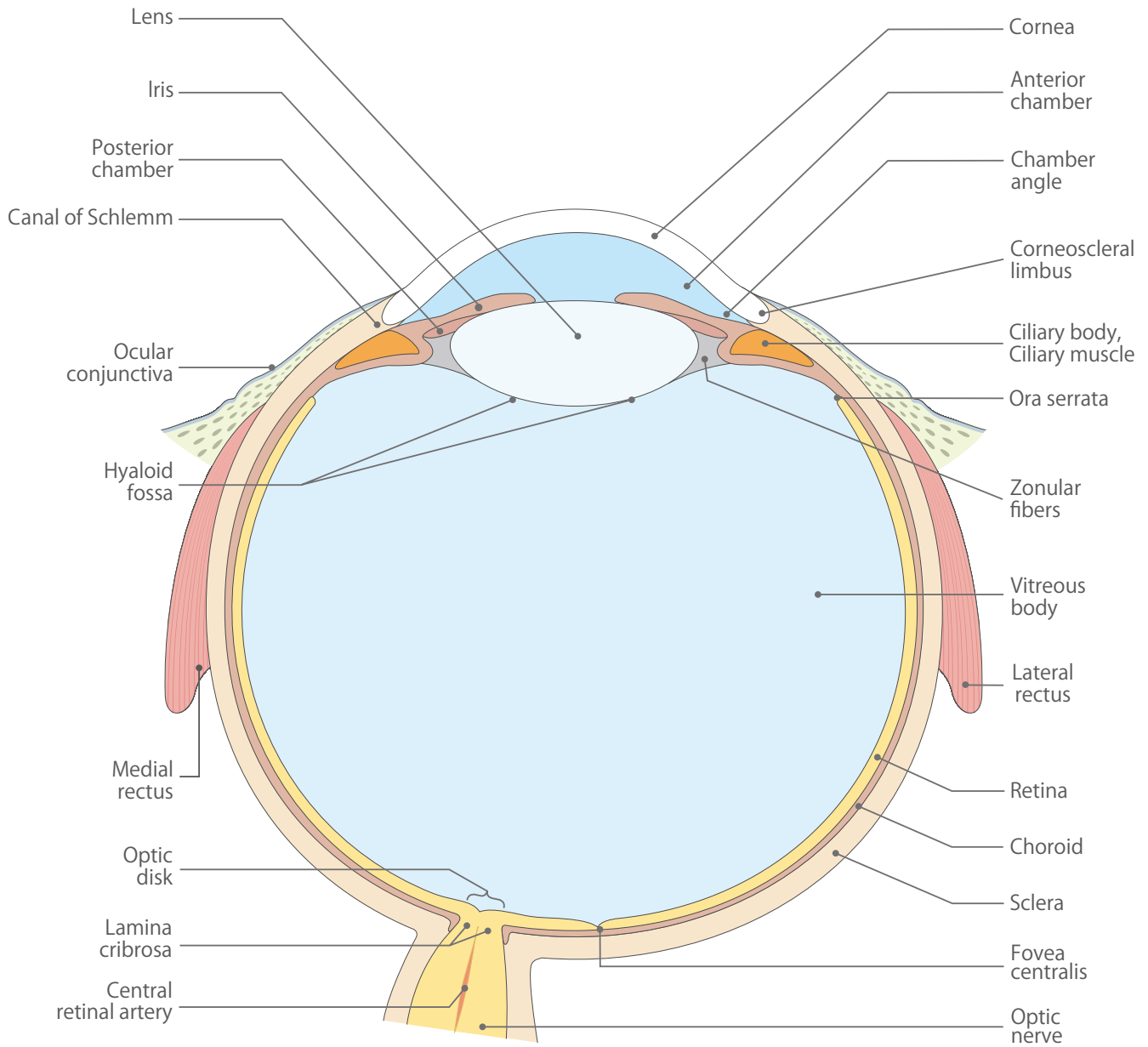

3 Outstanding Features of MANI® Ophthalmic Sutures

SHARPNESS

Crosslapped Edge

MANI's fine-processing technique has created the crosslapped edge which provides excellent sharpness and consistent quality. (Crosslapped edge: polishing direction is vertical to the edge)

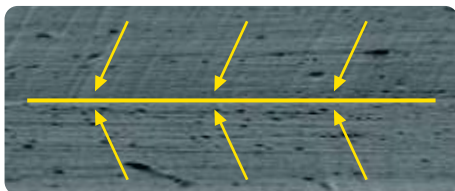

LASER DRILLED END

Atraumatic Needle

All MANI eyeless needles for Ophthalmic Sutures have a laser drilled end which does not make unnecessary trauma at tissue penetration.

Other

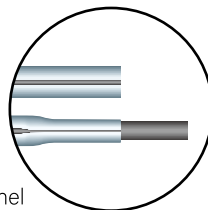

Channel

MANI®

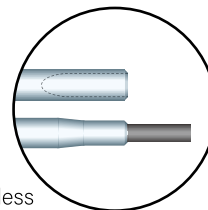

Eyeless

SUPERIOR IN SAFETY

"MANI's original hard fiber stainless steel"

MANI's original hard fiber stainless steel provides reliable strength on the tip to end. With this original material, MANI achieves a needle with high Ductility & high Bending Strength with corrosion resistance.

Structure of common stainless steel

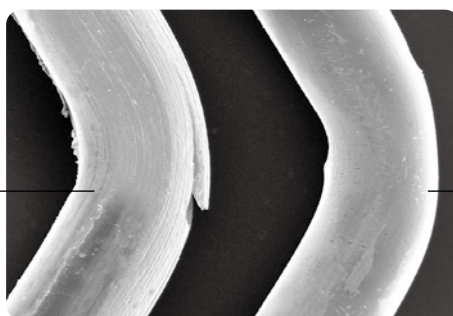
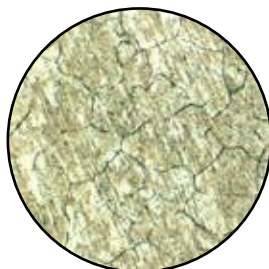

Structure of MANI® hard fiber stainless steel

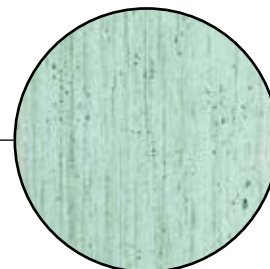

MANI, INC.

www.mani.co.jp/en

8-3 Kiyohara Industrial Park, Utsunomiya, Tochigi, 321-3231, Japan

Phone: +81-28-667-7565 FAX: +81-28-667-8305 e-Mail: seg-ovs@ms.mani.co.jp